

SPECIFICATION	VALUE
POWER (Kw)	3.0
VOLTAGE (VAC)	220
RATED CURRENT (A)	12
MAXIMUM SPEED (RPM)	24000
FREQUENCY (Hz)	400
NUT MODEL	ER20
COLLET (mm)	Ø6, Ø6.35
RUNOUT OFF (mm)	LESS THAN 0.005
BEARINGS	2x7005C(P4) + 1x7003C(P4)
COOLING	WATER COOLED
MATERIAL	STAINLESS STEEL
LUBRICATION	GREASE
WEIGHT (Kg) [lb]	9.1 [20.6]

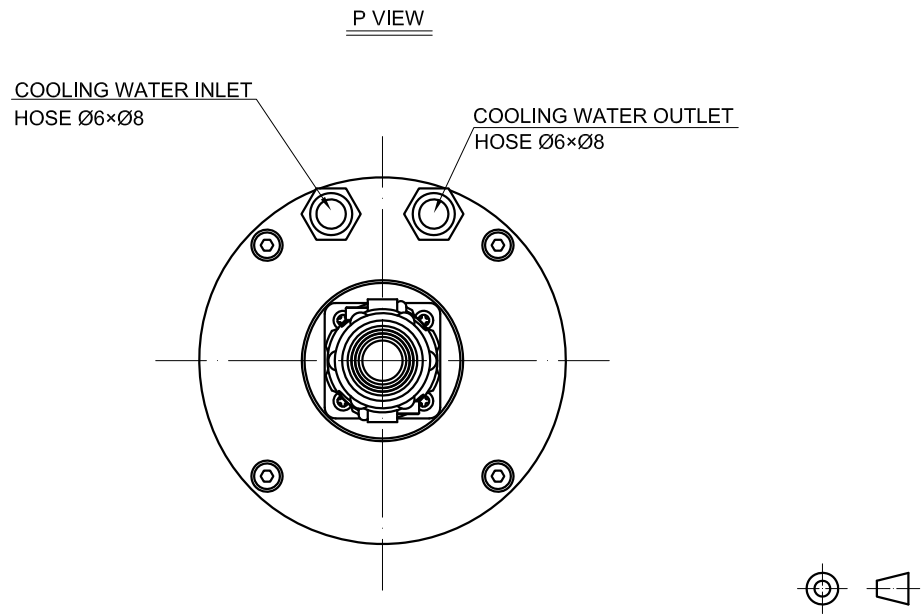

	mm	APVD		5.23.2019	<h2 style="margin: 0;">SPINDLE MOTOR</h2>
	UNIT	CHKD			
	2:1	DRN			<h2 style="margin: 0;">GDZ100-3.0B</h2>
	SCALE	SIGNATURE		DATE	