

SPEED - TORQUE CURVE

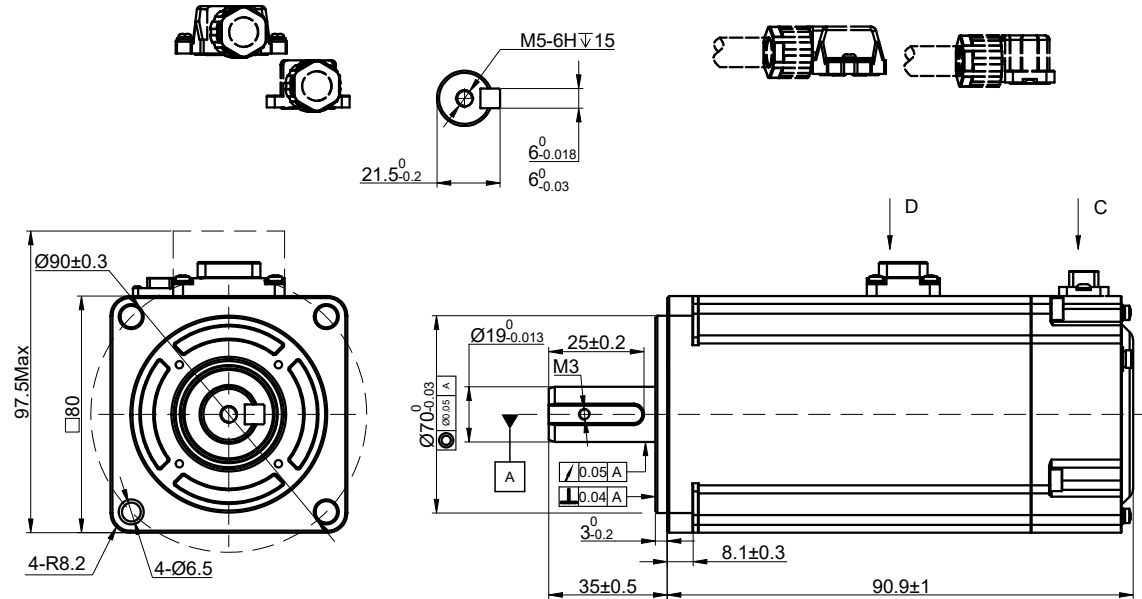
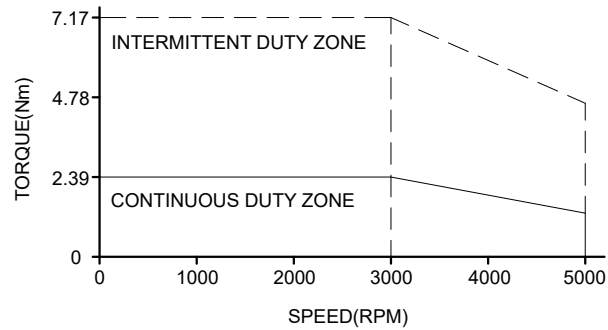

SPECIFICATION	VALUE
RATED VOLTAGE(VAC)	220
RATED POWER(W)	750
RATED TORQUE(Nm)	2.39
PEAK TORQUE(Nm)	7.17
RATED SPEED(RPM)	3000
PEAK SPEED(RPM)	5000
RATED CURRENT(Amp)	4.1
PEAK CURRENT(Amp)	13.4
TORQUE CONST(Nm/Amp)	0.645
BACK EMF CONST(V/KRPM)	39
RESISTANCE(Ω)	1.7
INDUCTANCE(mH)	8
INERTIA($Kg \cdot m^2 \cdot 10^{-4}$)	1.5
POLES	10
ENCODER TYPE	23bit magnetic
IP RATING	IP67
WEIGHT(KG)	2.12

WIRING DETAILS OF POWER CABLE CONNECTOR							
	PIN No.	1	2	3	4	--	--
	DESCRIPTION	U	W	V	PE	--	--
	COLOR	BLU	WHT	RED	YEL/GRN	--	--

WIRING DETAILS OF ENCODER CABLE CONNECTOR								
	PIN No.	1	2	3	4	5	6	7
	DESCRIPTION	PE	5V	0V	SD+	SD-	BAT+	BAT-
	COLOR	SHIELD	RED	BLK	BLU	YEL	BRN	WHT

THE PART NUMBER OF CABLE FOR T7M80-750H2A1-M23 MOTOR		
POWER CABLE	CMST1M5-2	AWG 20
ENCODER CABLE	CEST1M5-2	AWG 25



	APVD	LDJ	4.7.2024
	CHKD		
2:1	DRN	YSX	4.7.2024
SCALE	SIGNATURE	DATE	

AC SERVO MOTOR

T7M80-750H2A1-M23