



BS EN 62368-1



EN62368-1



UL61010-1



FEATURES

- Universal 85 - 305VAC or 120 - 430VDC Input voltage
- Accepts AC or DC input (dual-use of same terminal)
- Operating ambient temperature range: -40°C to +85°C
- High I/O Isolation test voltage up to 4000VAC
- Low ripple & noise
- Output short circuit, over-current, over-voltage, over-temperature protection
- DIN rail TS-35/7.5 or 15 mountable
- 3 years warranty
- Suitable for small chassis and narrow space installation
- Safety according to UL62368, EN60335, EN61558, GB4943

LI75-23BxxR3 is Mornsun AC-DC converter series featuring a cost-effective, energy efficient green power supply solution for standard DIN-rail mounting. The products offer a high level of stability and immunity to noise for industrial control equipment, machinery, and other industrial equipment in a variety of harsh environments. These light weight AC-DC converters have an extremely compact design and the standard rail installation for space saving. With good EMC performance, compliant with international UL61010, EN/UL/BS EN62368, EN60335, EN61558, GB4943 standards for EMC and safety.

Selection Guide

Certification	Part No.*	Output Power (W)	Nominal Output Voltage and Current (Vo/Io)	Output Voltage Adjustable Range (V)	Efficiency at 230VAC (%) Typ.	Max. Capacitive Load (µF)
EN/UL	LI75-23B12R3	75.6	12V/6.3A	12-14V	88	6000
	LI75-23B24R3	76.8	24V/3.2A	24-28V	90	1500
	LI75-23B48R3		48V/1.6A	48-53V	91	1000

Note: *Use suffix "Q" for conformal coating.

Input Specifications

Item	Operating Conditions		Min.	Typ.	Max.	Unit
Input Voltage Range	AC input		85	--	305	VAC
	DC input		120	--	430	VDC
Input Voltage Frequency			47	--	63	Hz
Input Current	115VAC		--	--	2	A
	230VAC		--	--	1	
Inrush Current	115VAC		--	30	--	
	230VAC		--	50	--	
Leakage Current	277VAC, 60Hz		<0.5mA			
Hot Plug			Unavailable			

Output Specifications

Item	Operating Conditions		Min.	Typ.	Max.	Unit
Output Voltage Accuracy	Full load range	12V	--	±2.0	--	%
		24V/48V	--	±1.0	--	
Line Regulation	Rated load		--	±0.5	--	
Load Regulation	0% - 100% load		--	±1.0	--	

Ripple & Noise*	20MHz bandwidth (peak-to-peak value)	12V	--	80	--	mV
		24V	--	120	--	
		48V	--	150	--	
Temperature Coefficient			--	±0.03	--	%/°C
Minimum Load			0	--	--	%
Stand-by Power Consumption	115VAC		--	0.5	1.0	W
	230VAC		--	1.0	1.5	
Hold-up Time	115VAC		--	12	--	ms
	230VAC		--	60	--	
Short Circuit Protection	Recovery time <5s after the short circuit disappear.		Constant current mode, continuous, self-recover			
Over-current Protection	230VAC, rated load	Normal temperature	110% Io - 150% Io, self-recover			
		High temperature, low temperature	≥105% Io, self-recover			
Over-voltage Protection	12V		≤17VDC (Hiccup, self-recover)			
	24V		≤33VDC (Hiccup, self-recover)			
	48V		≤60VDC (Hiccup, self-recover)			
Over-temperature Protection	230VAC, rated load		Output voltage turn off, self-recover after the temperature drops			
Note: *The "Tip and barrel method" is used for ripple and noise test, output parallel 47uF electrolytic capacitor and 0.1uF ceramic capacitor, please refer to Enclosed Switching Power Supply Application Notes for specific information.						

General Specifications

Item	Operating Conditions		Min.	Typ.	Max.	Unit
Isolation Test	Input - ⊕	Electric strength test for 1min., leakage current <10mA	2000	--	--	VAC
	Input - output		4000	--	--	
	Output - ⊕		500	--	--	
Insulation Resistance	Input - ⊕	At 500VDC	50	--	--	MΩ
	Input - output		50	--	--	
	Output - ⊕		50	--	--	
Operating Temperature			-40	--	+85	°C
Storage Temperature			-40	--	+85	
Operating Humidity	Non-condensing		10	--	95	%RH
Storage Humidity			20	--	95	
Switching Frequency			--	65	--	kHz
Power Derating	Operating temperature derating	-40°C to -30°C	5	--	--	% / °C
		+45°C to +85°C	2	--	--	
	Input voltage derating	85VAC - 100VAC	2	--	--	% / VAC
		277VAC - 305VAC	0.71	--	--	
Safety Standard			UL61010-1 safety approved & EN62368-1, BS EN62368-1 (Report) Design refer to EN60335-1, GB4943.1, IEC/UL62368-1, IEC/EN61558-1			
Safety Class			CLASS I			
MTBF	MIL-HDBK-217F@25°C		≥300,000 h			

Mechanical Specifications

Case Material	Metal (AL1100, SGCC)
Dimensions	110.00mm x 87.50mm x 32.00mm
Weight	340g (Typ.)
Cooling Method	Free air convection

Electromagnetic Compatibility (EMC)

Emissions	CE	CISPR32/EN55032	CLASS B	
	RE	CISPR32/EN55032	CLASS B	
	Harmonic current	IEC/EN61000-3-2	CLASS A	
Immunity	ESD	IEC/EN 61000-4-2	Contact ± 6 KV/Air ± 8 KV	perf. Criteria A
	RS	IEC/EN 61000-4-3	10V/m	perf. Criteria A
	EFT	IEC/EN 61000-4-4	± 2 KV	perf. Criteria A
	Surge	IEC/EN 61000-4-5	line to line ± 2 KV/line to ground ± 4 KV	perf. Criteria A
	CS	IEC/EN61000-4-6	10 Vr.m.s	perf. Criteria A
	MS	IEC/EN61000-4-8	30A/m	perf. Criteria A
	Voltage dips, short interruptions and voltage variations immunity	IEC/EN61000-4-11	0%, 70%	perf. Criteria B

Product Characteristic Curve

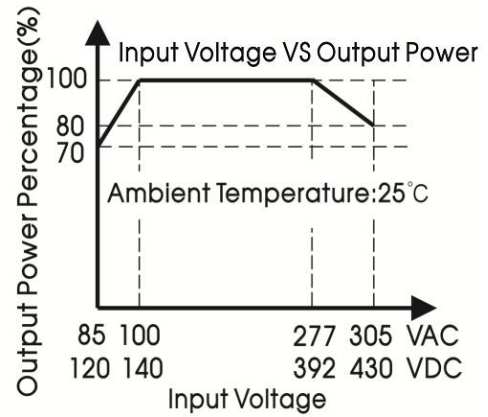
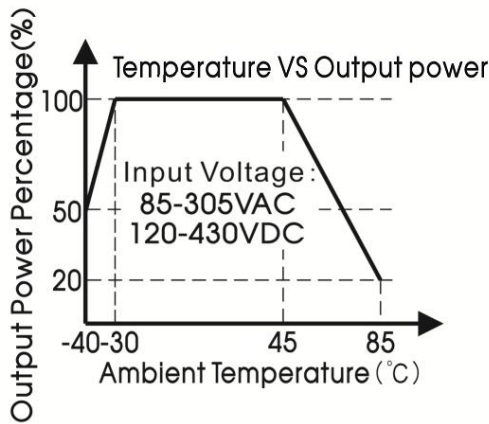

- Note: 1. With an AC input voltage between 85 - 100VAC/277 - 305VAC and a DC input between 120 - 140VDC/392 - 430VDC the output power must be derated as per the temperature derating curves;
 2. This product is suitable for applications using natural air cooling; for applications in closed environment please consult Mornsun FAE.

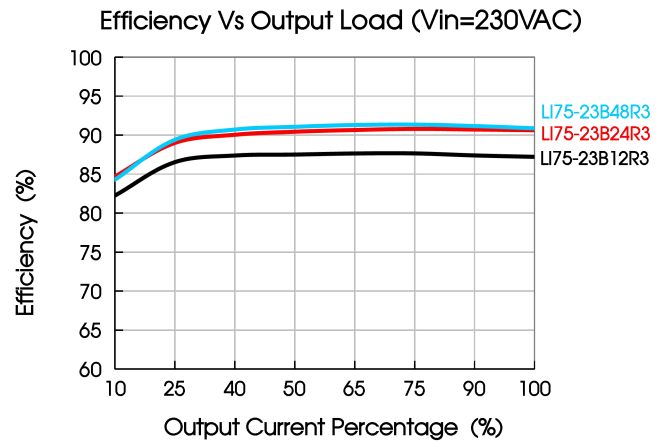
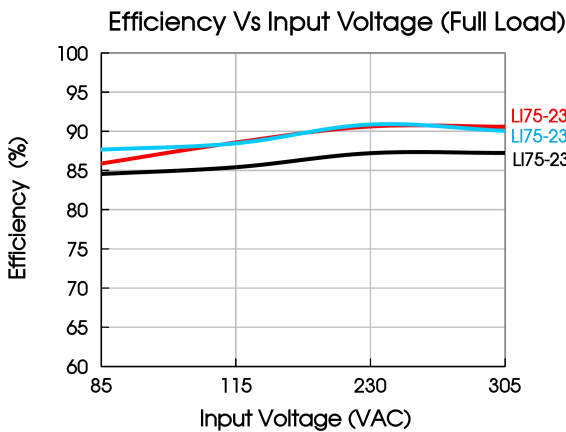

Installation Diagram

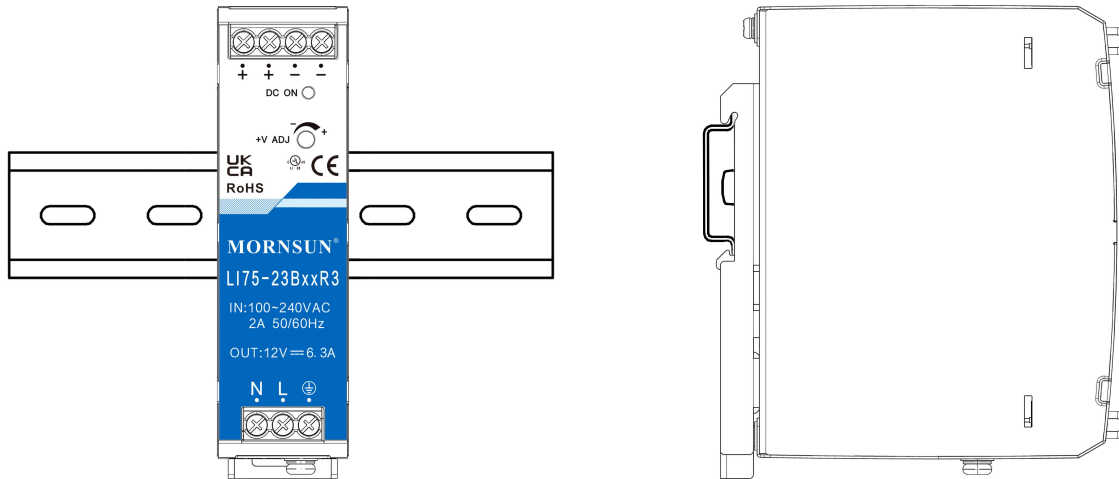

Bill Of Material		
1	Product	1 PCS
2	Phillips screwdriver Slotted screwdriver	1 PCS
3	TS35/7.5 or TS35/15	1 PCS
4	26-10AWG wires	/ PCS
All above is only for reference, the actual wiring diameter and locking torque refer to the appearance size diagram		

Installation steps ①-②

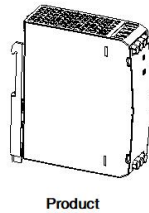

Product

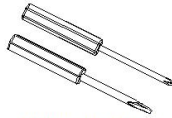

Phillips screwdriver
Slotted screwdriver
Diameter of the cutting tools: 3mm

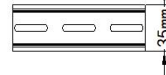

TS35/7.5 or TS35/15

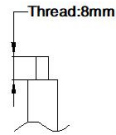

26-10AWG wires

① Put the product buckle down into the TS35 rail.

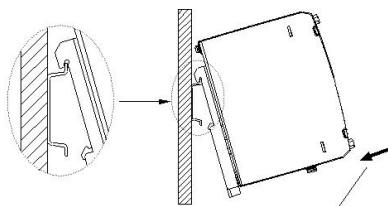

② Push the product perpendicular to the TS35 rail until hear the sound of the clip snapping into the rail.

Disassembly steps ③-④

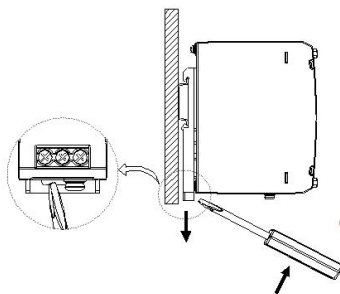

③ After inserting a Slotted screwdriver into the square groove at the bottom of the buckle, push the sliding part of the buckle downward according to the direction shown.

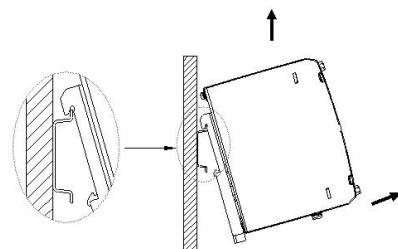

④ Push the bottom of the product outwards and take it out upwards.

Connecting/Disconnecting Steps ⑤-⑥

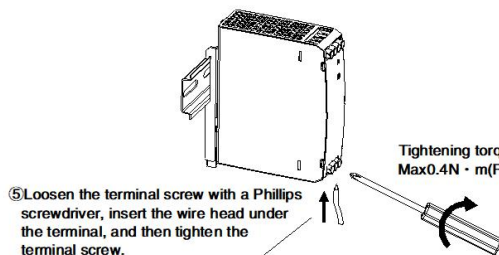

⑤ Loosen the terminal screw with a Phillips screwdriver, insert the wire head under the terminal, and then tighten the terminal screw.

Tightening torque:
Max0.4N·m(Reference);

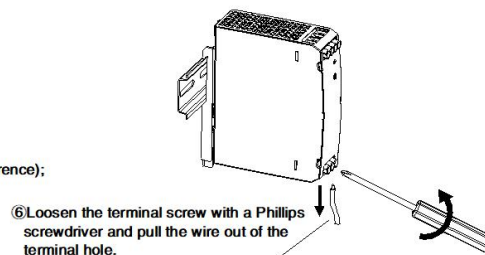

⑥ Loosen the terminal screw with a Phillips screwdriver and pull the wire out of the terminal hole.

AC/DC 75W DIN-Rail Power Supply

LI75-23BxxR3, LI75-23BxxR3-Q Series

MORNSUN®

Note: Keep the following installation clearances: 20mm on top, 20mm on the bottom, 5mm on the left and right sides are recommended when the device is loaded permanently with more than 50% of the rated power. Increase this clearance to 15mm in case the adjacent device is a heat source (e.g. another power supply).

Dimensions and Recommended Layout

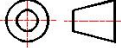
THIRD ANGLE PROJECTION 

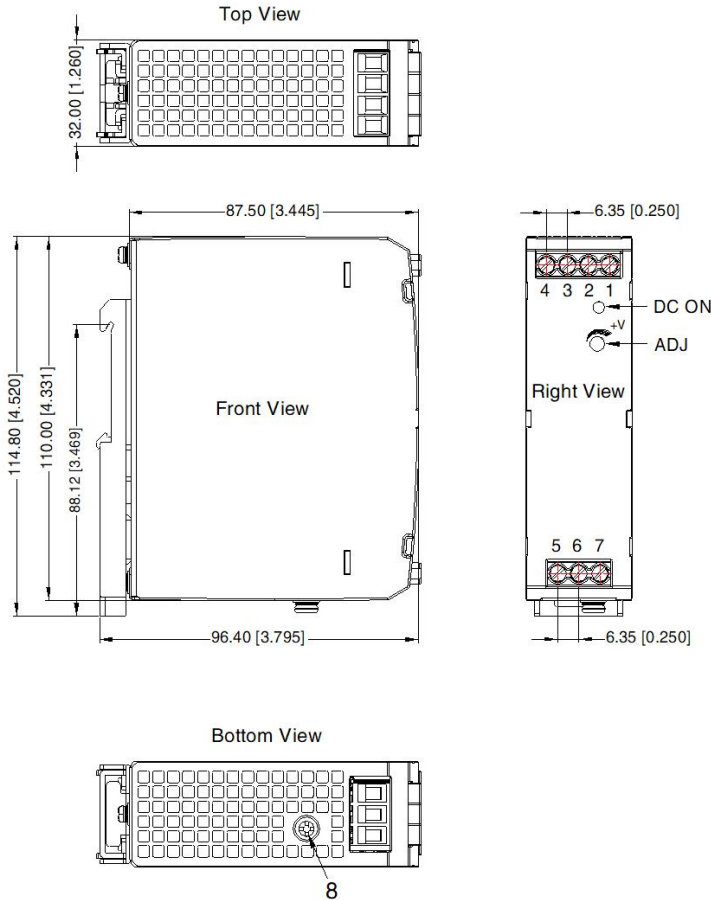

Pin-Out	
Pin	Mark
1	-Vo
2	-Vo
3	+Vo
4	+Vo
5	AC(N)
6	AC(L)
7	

7, 8 any position must be connected to the earth ()

Note:
 Unit: mm[inch]
 ADJ: Output adjustable resistor
 Wire range: 26-10 AWG
 Tightening torque: Max 0.4 N-m
 Mounting rail: TS35, rail needs to connect safety ground
 General tolerances: $\pm 1.00 [\pm 0.039]$

Note:

- For additional information on Product Packaging please refer to www.mornsun-power.com. Packaging bag number: 58220280;
- Unless otherwise specified, parameters in this datasheet were measured under the conditions of $T_a=25^\circ\text{C}$, humidity <75% RH with nominal input voltage and rated output load;
- The room temperature derating of $5^\circ\text{C}/1000\text{m}$ is needed for operating altitude greater than 2000m;
- All index testing methods in this datasheet are based on our company corporate standards;
- In order to improve the efficiency at high input voltage, there will be audible noise generated, but it does not affect product performance and reliability;
- We can provide product customization service, please contact our technicians directly for specific information;
- Products are related to laws and regulations: see "Features" and "EMC";
- The out case needs to be connected to PE () of system when the terminal equipment in operating;
- The output voltage can be adjusted by the ADJ, clockwise to increase;
- Our products shall be classified according to ISO14001 and related environmental laws and regulations, and shall be handled by qualified units;
- The power supply is considered a component which will be installed into a terminal equipment. All EMC tests should be confirmed with the final equipment. Please consult our FAE for EMC test operation instructions.

Mornsun Guangzhou Science & Technology Co., Ltd.

Address: No. 5, Kehui St. 1, Kehui Development Center, Science Ave., Guangzhou Science City, Huangpu District, Guangzhou, P. R. China

MORNSUN®

MORNSUN Guangzhou Science & Technology Co., Ltd.

