



500W Single Output with PFC Function

RSP-500 series



Dimension			
L	W	H	
230	127	40.5(1U)	mm
9.06	5	1.59(1U)	inch



Features

- Universal AC input / Full range
- Built-in active PFC function
- High efficiency up to 90.5%
- Forced air cooling by built-in DC fan (Note.5)
- Built-in remote ON-OFF control / remote sense / DC OK signal
- Protections: Short circuit / Overload / Over voltage / Over temperature
- 3 years warranty

Applications

- Factory control or automation apparatus
- Test and measurement instrument
- Laser related machine
- Burn-in facility
- RF application

GTIN CODE

MW Search: <https://www.meanwell.com/serviceGTIN.aspx>

Description

RSP-500 is a 500W single output enclosed type AC/DC power supply. This series operates for 85~264VAC input voltage and offers the models with the DC output mostly demanded from the industry. Each model is cooled by the built-in fan with fan speed control, working for the temperature up to 70°C. Moreover, RSP-500 provides vast design flexibility by equipping various built-in functions such as remote ON-OFF control, remote sense, DC OK signal, etc.

Model Encoding / Order Information

RSP - 500 - 24

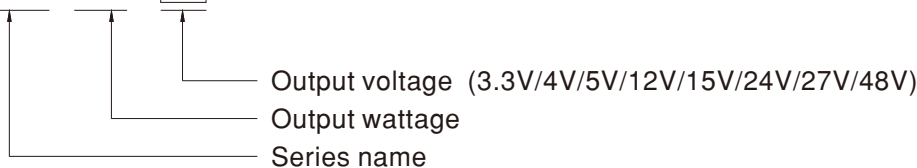



SPECIFICATION

MODEL	RSP-500-3.3	RSP-500-4	RSP-500-5	RSP-500-12	RSP-500-15	RSP-500-24	RSP-500-27	RSP-500-48	
OUTPUT	DC VOLTAGE	3.3V	4V	5V	12V	15V	24V	27V	48V
	RATED CURRENT	90A	90A	90A	41.7A	33.4A	21A	18.6A	10.5A
	CURRENT RANGE	0 ~ 90A	0 ~ 90A	0 ~ 90A	0 ~ 41.7A	0 ~ 33.4A	0 ~ 21A	0 ~ 18.6A	0 ~ 10.5A
	RATED POWER	297W	360W	450W	500.4W	501W	504W	502.2W	504W
	RIPPLE & NOISE (max.) Note.2	120mVp-p	120mVp-p	150mVp-p	150mVp-p	150mVp-p	150mVp-p	150mVp-p	150mVp-p
	VOLTAGE ADJ. RANGE	2.8 ~ 3.6V	3.6 ~ 4.3V	4.5 ~ 5.5V	10 ~ 13.2V	13.5 ~ 18V	20 ~ 26.4V	26 ~ 30V	41 ~ 56V
	VOLTAGE TOLERANCE Note.3	±2.0%	±2.0%	±2.0%	±1.0%	±1.0%	±1.0%	±1.0%	±1.0%
	LINE REGULATION	±0.5%	±0.5%	±0.5%	±0.3%	±0.3%	±0.2%	±0.2%	±0.2%
	LOAD REGULATION	±1.0%	±1.0%	±1.0%	±0.5%	±0.5%	±0.5%	±0.5%	±0.5%
	SETUP, RISE TIME	1500ms, 80ms/230VAC 3000ms, 80ms/115VAC at full load							
HOLD UP TIME (Typ.)	18ms/230VAC 14ms/115VAC at full load								
INPUT	VOLTAGE RANGE Note.4	85 ~ 264VAC 120 ~ 370VDC							
	FREQUENCY RANGE	47 ~ 63Hz							
	POWER FACTOR (Typ.)	PF>0.95/230VAC PF>0.98/115VAC at full load							
	EFFICIENCY (Typ.)	81%	83%	84%	88%	88%	89%	89.5%	90.5%
	AC CURRENT (Typ.)	4.2A/115VAC		2.1 A/230VAC		5.3A/115VAC		2.65 A/230VAC	
	INRUSH CURRENT (Typ.)	20A/115VAC		40A/230VAC					
	LEAKAGE CURRENT	<2mA / 240VAC							
PROTECTION	OVERLOAD	105 ~ 130% rated output power Protection type : Constant current limiting, recovers automatically after fault condition is removed							
	OVER VOLTAGE	3.8 ~ 4.5V	4.5 ~ 5.3V	5.75 ~ 6.75V	13.8 ~ 16.2V	18.8 ~ 21.8V	27.6 ~ 32.4V	32.9 ~ 38.3V	58.4 ~ 68V
	OVER TEMPERATURE	Shut down o/p voltage, recovers automatically after temperature goes down							
FUNCTION	REMOTE CONTROL	POWER ON: open or 0~0.8VDC between RC+(Pin 4)&RC-(Pin3) on CN100 POWER OFF: 4~10VDC between RC+(Pin 4)&RC-(Pin3) on CN100							
	REMOTE SENSE	Compensate voltage drop on the load wiring up to 0.3V							
	FAN CONTROL (Typ.)	RTH2≥50°C±10°C Fan on ; RTH2≤40°C±10°C Fan off (Fan always on for 3.3~5V, Fan ON/OFF control for 12~48V)							
ENVIRONMENT	WORKING TEMP.	-30 ~ +70°C (Refer to "Derating Curve")							
	WORKING HUMIDITY	20 ~ 90% RH non-condensing							
	STORAGE TEMP., HUMIDITY	-40 ~ +85°C, 10 ~ 95% RH							
	TEMP. COEFFICIENT	±0.03%/°C (0 ~ 50°C)							
	VIBRATION	10 ~ 500Hz, 2G 10min./1cycle, 60min. each along X, Y, Z axes							
SAFETY & EMC (Note.4)	SAFETY STANDARDS	UL62368-1, TUV BS EN/EN62368-1, AS/NZS 62368.1, EAC TP TC 004 , CCC GB4943.1 , BSMI CNS14336-1approved							
	WITHSTAND VOLTAGE	I/P-O/P:3KVAC I/P-FG:2KVAC O/P-FG:0.5KVAC							
	ISOLATION RESISTANCE	I/P-O/P, I/P-FG, O/P-FG:100M Ohms / 500VDC / 25°C / 70% RH							
	EMC EMISSION	Compliance to BS EN/EN55032 (CISPR32) Class B, BS EN/EN61000-3-2,-3, EAC TP TC 020,GB/T 9254, CNS13438 Class B							
OTHERS	EMC IMMUNITY	Compliance to BS EN/EN61000-4-2,3,4,5,6,8,11, BS EN/EN55024, BS EN/EN61000-6-2, EAC TP TC 020							
	MTBF	1372.4K hrs min. Telcordia SR-332 (Bellcore) ; 187.9K hrs min. MIL-HDBK-217F (25°C)							
	DIMENSION	230*127*40.5mm (L*W*H)							
	PACKING	1.3Kg; 9pcs/12.7Kg/0.7CUFT							
NOTE	<p>1. All parameters NOT specially mentioned are measured at 230VAC input, rated load and 25°C of ambient temperature.</p> <p>2. Ripple & noise are measured at 20MHz of bandwidth by using a 12" twisted pair-wire terminated with a 0.1uf & 47uf parallel capacitor.</p> <p>3. Tolerance : includes set up tolerance, line regulation and load regulation.</p> <p>4. Derating may be needed under low input voltages. Please check the derating curve for more details.</p> <p>5. Fan always on for 3.3~5V, Fan ON/OFF control for 12~48V.</p> <p>6. The power supply is considered a component which will be installed into a final equipment. The final equipment must be re-confirmed that it still meets EMC directives. For guidance on how to perform these EMC tests, please refer to "EMI testing of component power supplies." (as available on http://www.meanwell.com)</p> <p>7. The ambient temperature derating of 3.5°C/1000m with fanless models and of 5°C/1000m with fan models for operating altitude higher than 2000m(6500ft).</p> <p>※ Product Liability Disclaimer : For detailed information, please refer to https://www.meanwell.com/serviceDisclaimer.aspx</p>								

■ Mechanical Specification

Case No.226A Unit:mm

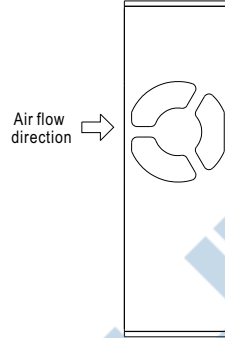
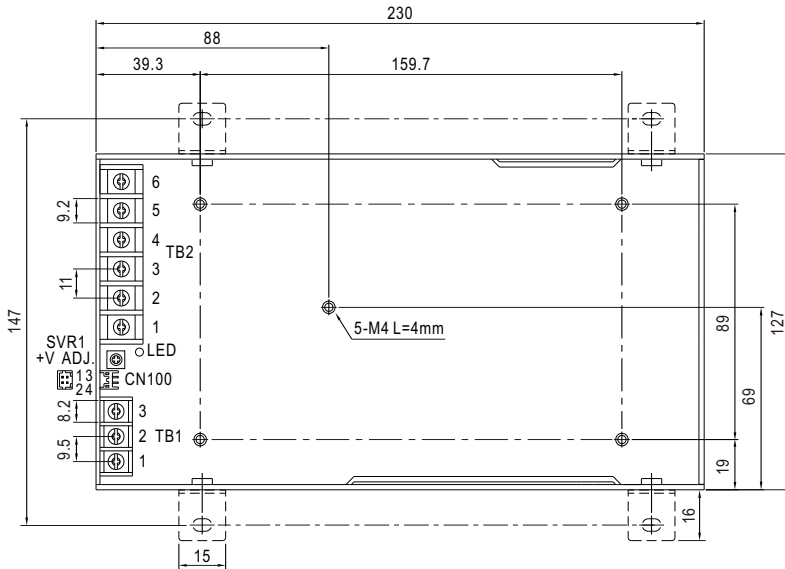

AC Input Terminal
Pin No. Assignment (TB1)

Pin No.	Assignment
1	AC/L
2	AC/N
3	FG \pm

DC Output Terminal
Pin No. Assignment (TB2)

Pin No.	Assignment
1-3	DC OUTPUT -V
4-6	DC OUTPUT +V

Connector Pin No. Assignment (CN100) :
HRS DF11-04DP-2DS or equivalent

Pin No.	Assignment	Mating Housing	Terminal
1	-S	HRS DF11-4DS or equivalent	HRS DF11-**-SC or equivalent
2	+S		
3	RC-		
4	RC+		

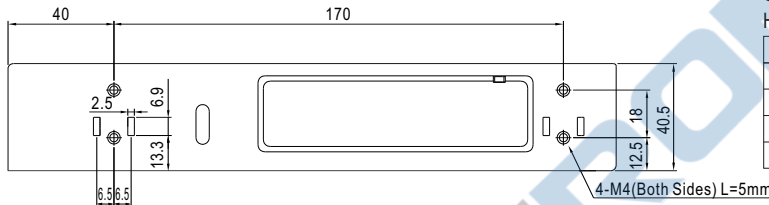

■ Block Diagram

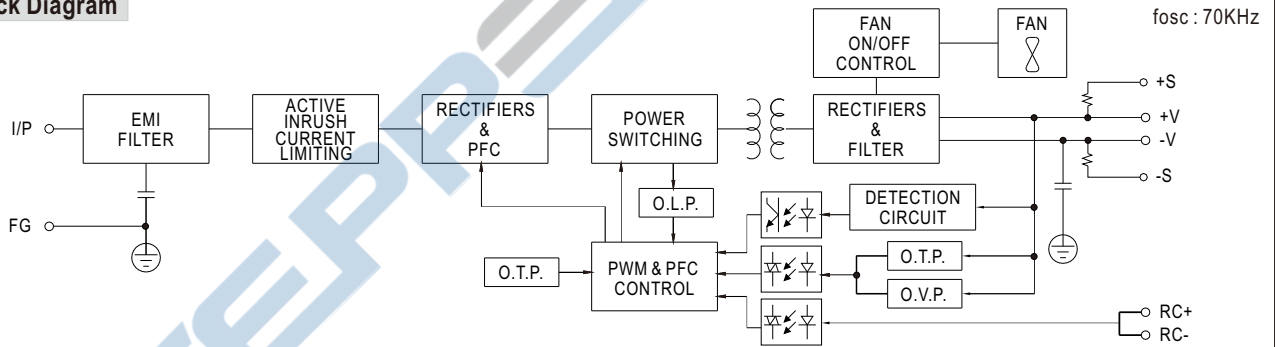

■ Derating Curve

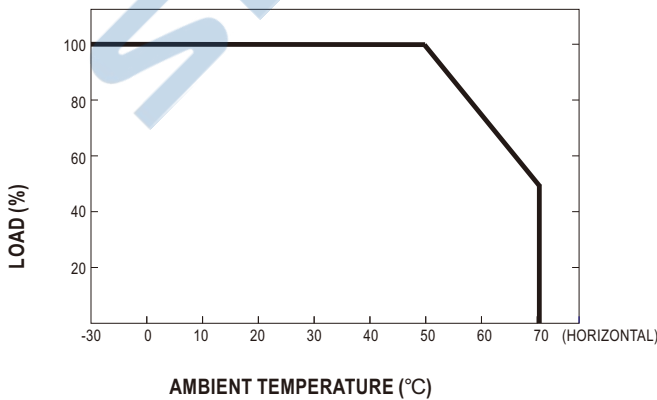

■ Static Characteristics

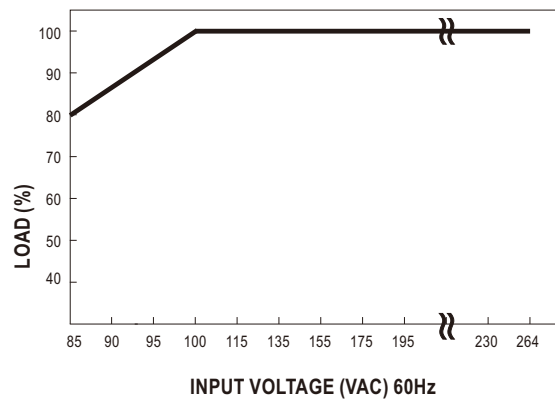

■ Function Description of CN100

Pin No.	Function	Description
1	-S	Negative sensing. The -S signal should be connected to the negative terminal of the load. The -S and +S leads should be twisted in pair to minimize noise pick-up effect. The maximum line drop compensation is 0.3V.
2	+S	Positive sensing. The +S signal should be connected to the positive terminal of the load. The +S and -S leads should be twisted in pair to minimize noise pick-up effect. The maximum line drop compensation is 0.3V.
3	RC-	Return for RC+ signal input.
4	RC+	Turns the output on and off by electrical or dry contact between pin 4 (RC+) and pin 3 (RC-). 0~0.8VDC or open: Power ON, 4~10VDC: Power OFF.

■ Function Manual

1. Remote Control

The PSU can be turned ON/OFF by using the "Remote Control" function.

Between RC-(pin3) and RC+(pin4) on CN100	PSU Status
SW OFF (0 ~ 0.8VDC) or open	ON
SW ON (4 ~ 10V)	OFF

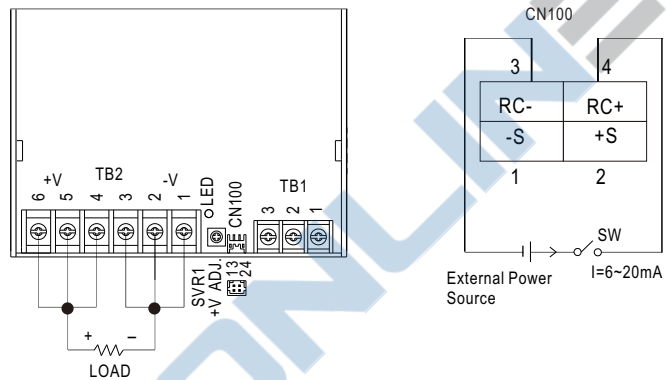

2. Remote Sense

The remote sense compensates voltage drop on the load wiring up to 0.3V

