

PLAIN WASHER

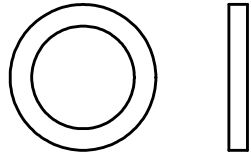

CIRCLIP

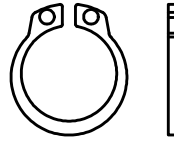

KEY

SHAFT

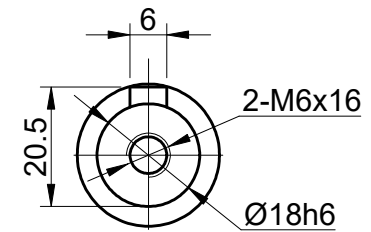
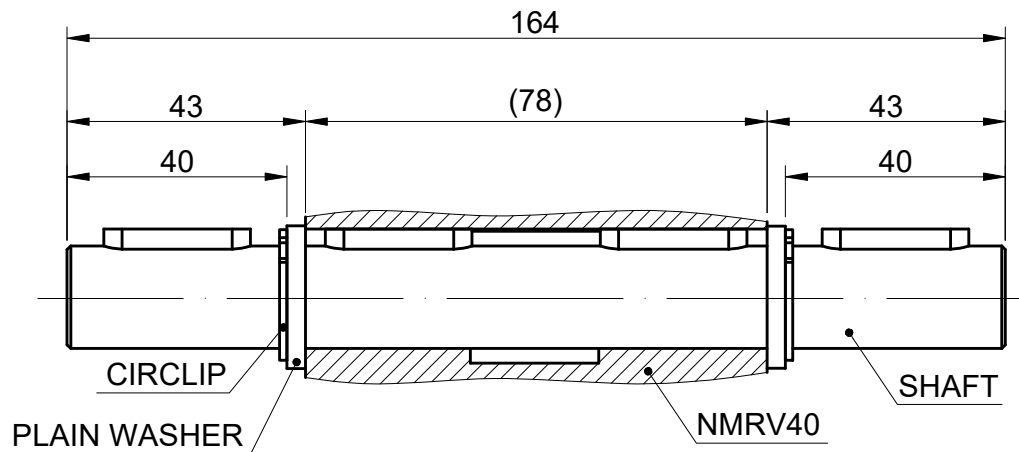

STEPPERONLINE®

	APVD	YSX	9.1.2023
	CHKD		
1:1	DRN	LDJ	9.1.2023
SCALE	SIGNATURE	DATE	

WORM GEARBOX OUTPUT SHAFT

RV40-AB

REV.	0	DWG NO.	A2430
------	---	---------	-------