

REV.	REVISION RECORD	BY	DATE
0	ORIGIN	HW	3.8.2024

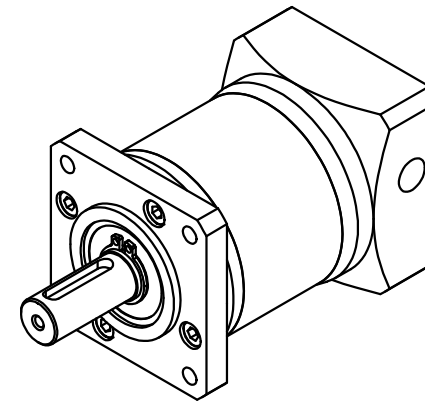
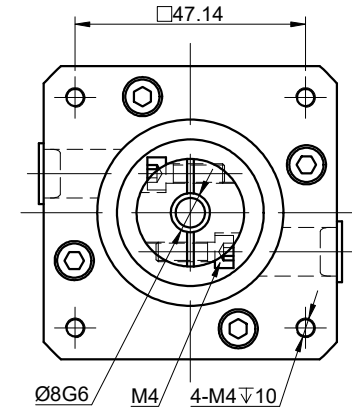
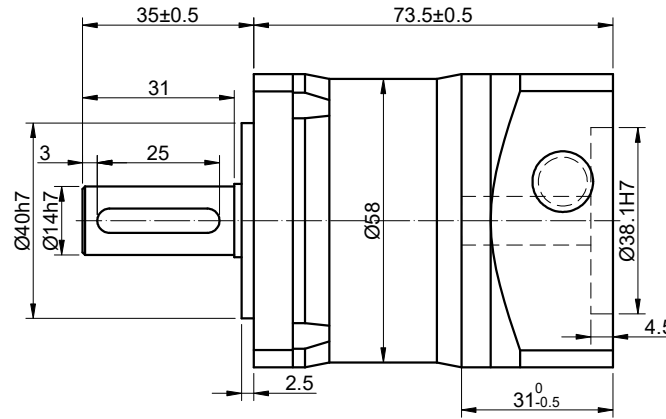
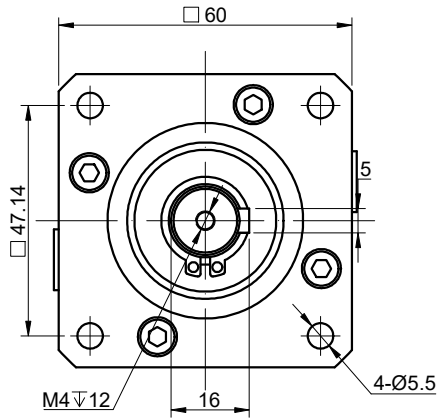

SPECIFICATION	CONNECTION	VALUE
GEAR RATIO		10
EFFICIENCY		94%
BACKLASH@NO-LOAD(arcmin)		<=15
MAX.PERMISSIBLE TORQUE(Nm)[lb-in]		10.00[88.51]
MOMENT PERMISSIBLE TORQUE(Nm)[lb-in]		20.00[177.01]
SHAFT MAXIMUM AXIAL LOAD(N)		200
SHAFT MAXIMUM RADIAL LOAD(N)		400
GEARBOX MATCHING MOTOR'S INPUT SHAFT LENGTH (mm)		12-31
RATED INPUT SPEED(RPM)		3000
MAX. INPUT SPEED(RPM)		6000
NOISE(dB)		<=65
WATERPROOF RATING		IP54
LIFE(h)		20000
WORKING TEMPERATURE		-20°C~150°C[-4°F~302°F]

DIMENSIONS ARE IN MILLIMETERS.  
TOLERANCES AS BELOW:  
DECIMALS ANGLES  
X ±0.5 ±2°  
X.X ±0.25  
X.XX ±0.13

THIRD ANGLE PROJECTION		
SIGNATURE		DATE
DRN	HW	3.8.2024
APVD	LDJ	3.8.2024

<b>STEPPERONLINE®</b>									
PLANETARY GEARBOX									
EG23-G10-D8									
REV.	0	SCALE	2:3	DWG NO.	A1777				