

REV.	REVISION RECORD	BY	DATE
0	ORIGIN	LJ	3.31.2026

CUSTOMER'S MODEL:
END COVER COLOR: BLACK

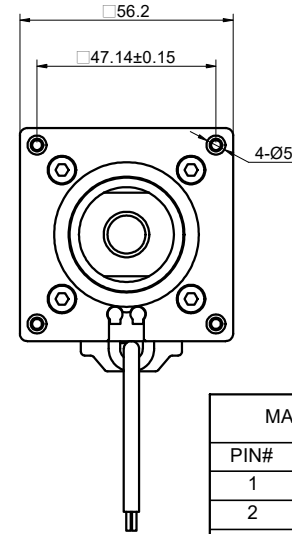

ELECTRIC CYLINDER
LCB23S22BVL30-150D
S/N: XXXXXXXXXXXX

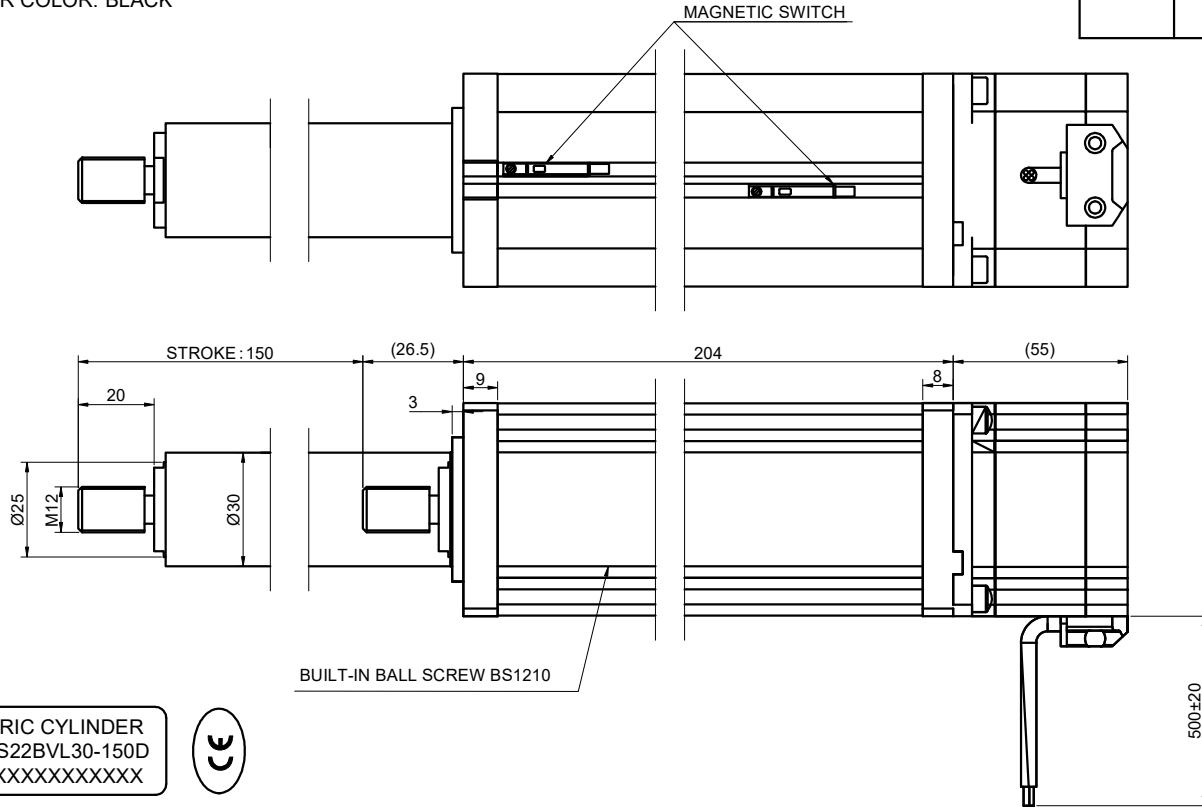

MAGNETIC SWITCH WIRING		
PIN#	DESCRIPTION	COLOUR
1	DC 5-24V	BROWN
2	GND	BLUE
3	SIGNAL	BLACK

CONNECTION	BIPOLAR
SPECIFICATION	
AMPS/PHASE	3.00
RESISTANCE/PHASE(Ohms)@25°C	1.10±10%
INDUCTANCE/PHASE(mH)@1KHz	4.50±20%
HOLDING TORQUE(Nm)[lb-in]	1.20[10.62]
STEP ANGLE(°)	1.80
STEP ACCURACY(NON-ACCUM)	±5.00%
LEAD(mm)	10
LINEAR TRAVEL/STEP(mm)	0.05
AMBIENT TEMPERATURE	-20°C~50°C[-4°F~122°F]
INSULATION CLASS	B 130°C[266°F]
TEMPERATURE RISE	MAX.80°C
AMBIENT HUMIDITY	MAX.85%

- NOTICE:
1. MOTOR SCREW SHALL NOT BE SUBJECTED TO RADIAL LOAD.
 2. NOT CLAMP OR SQUEEZE THE MOTOR SCREW WITH HARD OBJECTS, SO AS TO AVOID DAMAGING THE THREAD.
 3. MOTOR SCREW IS PRE-COATED WITH SPECIAL GREASE. PLEASE CONTACT THE MANUFACTURER IF RE-GREASING IS REQUIRED.
 4. DO NOT DISASSEMBLE THE MOTOR WITHOUT PERMISSION.
 5. MOTOR MUST BE HANDLED WITH CARE. HOLD THE MOTOR BODY WHEN CARRYING IT; DO NOT LIFT IT BY THE LEAD WIRES.

MOTOR CONNECTION			
PIN NO	BIPOLAR	LEADS	WINDING
1	A+	RED	
2	A-	RED/WHT	
3	B+	GRN	
4	B-	GRN/WHT	

FULL STEP 2 PHASE-Ex.,WHEN FACING MOUNTING END (X)					CCW	CW	DIMENSIONS ARE IN MILLIMETERS. TOLERANCES AS BELOW: DECIMALS ANGLES X ±0.5 ±2° X.X ±0.25 X.XX ±0.13
STEP	A+	B+	A-	B-			
1	+	+	-	-			
2	-	+	+	-			
3	-	-	+	+			
4	+	-	-	+			



ELECTRIC CYLINDER

LCB23S22B1L30-150D

THIS DOCUMENT SHALL NOT BE REPRODUCED NOR SHALL THE INFORMATION CONTAINED HEREIN BE USED BY OR DISCLOSED TO OTHERS UNLESS EXPRESSLY AUTHORIZED IN BY WRITING STEPPERONLINE.

SIGNATURE		DATE
DRN	LJ	3.31.2026
APVD	MYX	3.31.2026