

CUSTOMER'S MODEL: NO MODEL
 END COVER COLOR: BLACK

REV.	REVISION RECORD	BY	DATE
0	ORIGIN	MYX	8.13.2025

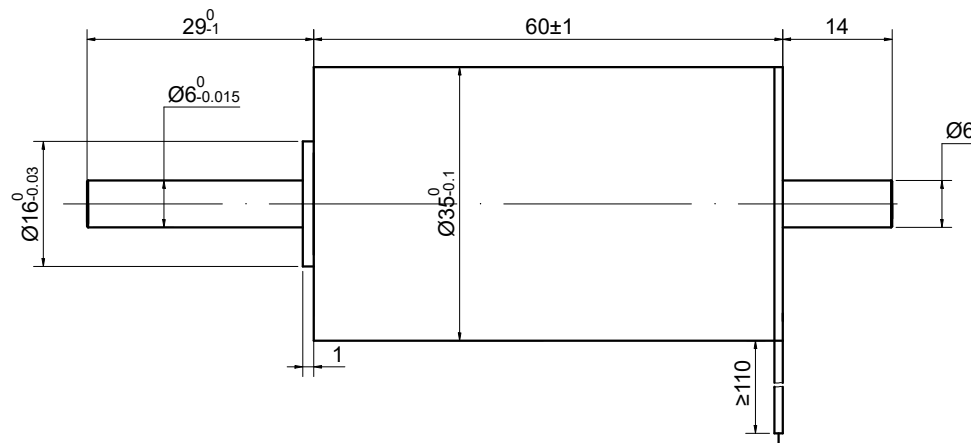
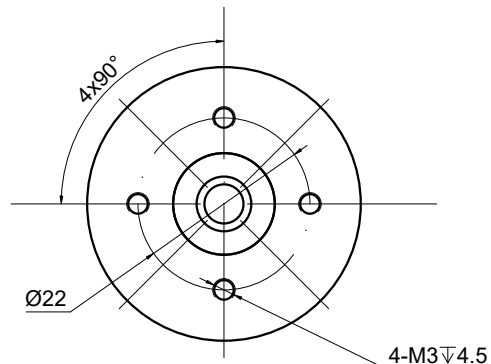

SPECIFICATION	VALUE
RATED VOLTAGE(V)	36
TERMINAL RESISTANCE(Ohms)	0.51
TERMINAL INDUCTANCE(mH)	0.12
NO LOAD SPEED(RPM)	15000
NO LOAD CURRENT(A)	0.35
RATED SPEED(RPM)	10000
RATED CURRENT(A)	6.14
RATED TORQUE(mNm)	140
RATED POWER(W)	146.60
THE GREATEST POWER OUTPUT(W)	629.01
EFFICIENCY(%)	86.41
TORQUE CONSTANT (mNm/A)	22.80
STALL TORQUE (mNm)	1601.76
BACK-EMF CONSTANT (mV/RPM)	2.39
SPEED CONSTANT (RPM/V)	418.74
FRICTION TORQUE(mNm)	7.98
CURRENT CONSTANT (A/mNm)	0.04

1. OPERATING TEMPERATURE RANGE:
 -20°C~80°C[-4°F~176°F]

2. WINDING MAX PERMISSIBLE:
 180°C[356°F]

3. NO. of POLES: 2

THIS DOCUMENT SHALL NOT BE REPRODUCED NOR SHALL THE INFORMATION CONTAINED HEREIN BE USED BY OR DISCLOSED TO OTHERS UNLESS EXPRESSLY AUTHORIZED IN BY WRITING STEPPERONLINE.

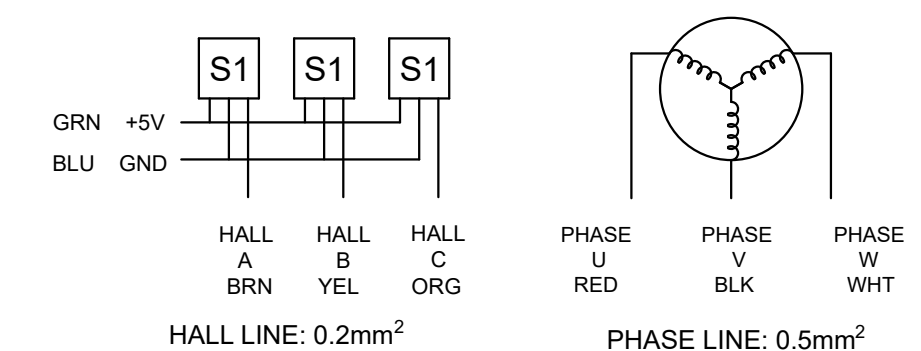

DIMENSIONS ARE IN MILLIMETERS.
 TOLERANCES AS BELOW:
 DECIMALS ANGLES
 X ±0.5 ±2°
 X.X ±0.25
 X.XX ±0.13

THIRD ANGLE PROJECTION

STEPPERONLINE®

BRUSHLESS DC MOTOR

35CL60-36-P2-10000

REV.	0	SCALE	1:1	DWG NO.	A4878
------	---	-------	-----	---------	-------

SIGNATURE		DATE
DRN	MYX	8.13.2025
APVD	LDJ	8.13.2025