

REV.	REVISION RECORD	BY	DATE
0	ORIGIN	LJ	8.12.2025

CUSTOMER'S MODEL: NO MODEL
 END COVER COLOR: BLACK

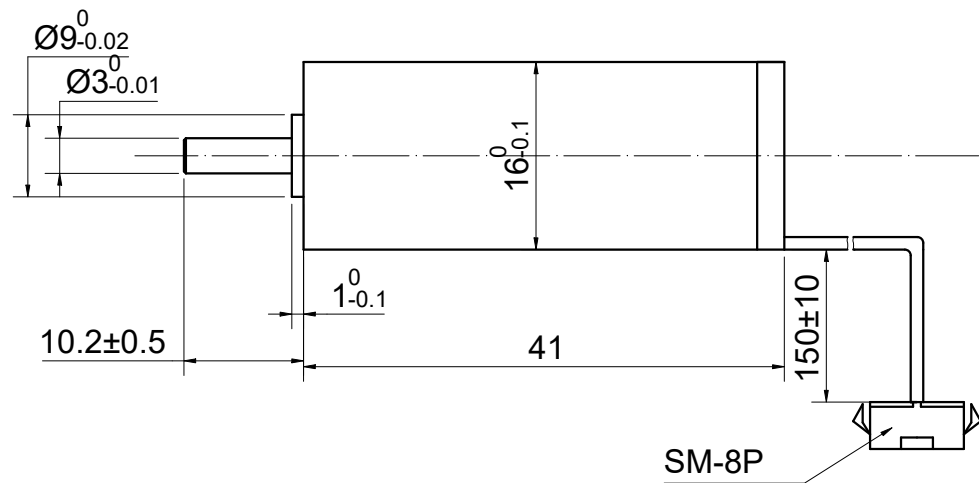
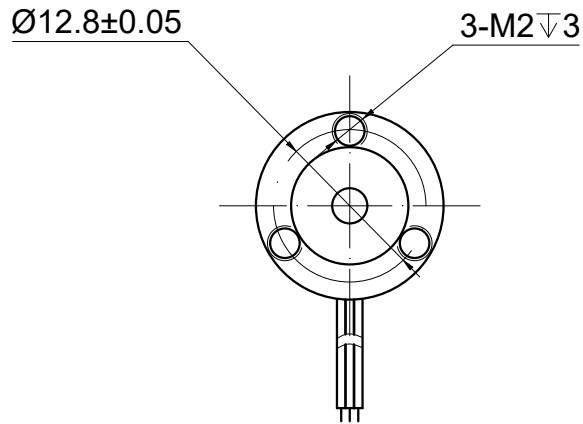

SPECIFICATION	VALUE
RATED VOLTAGE(V)	12
TERMINAL RESISTANCE(Ohms)	1.1
TERMINAL INDUCTANCE(mH)	0.07
NO LOAD SPEED(RPM)	12000
NO LOAD CURRENT(A)	0.35
RATED SPEED(RPM)	7300
RATED CURRENT(A)	1.00
RATED TORQUE(mNm)	9.2
RATED POWER(W)	7.03
THE GREATEST POWER OUTPUT(W)	30.66
EFFICIENCY(%)	67.38
TORQUE CONSTANT (mNm/A)	9.24
STALL TORQUE (mNm)	97.60
BACK-EMF CONSTANT (mV/RPM)	0.97
SPEED CONSTANT (RPM/V)	1033.15
FRICTION TORQUE(mNm)	3.24
CURRENT CONSTANT (A/mNm)	0.11

1. OPERATING TEMPERATURE RANGE:
 -20°C~80°C[-4°F~176°F]

2. WINDING MAX PERMISSIBLE:
 180°C[356°F]

3. NO. of POLES: 2

THIS DOCUMENT SHALL NOT BE REPRODUCED NOR SHALL THE INFORMATION CONTAINED HEREIN BE USED BY OR DISCLOSED TO OTHERS UNLESS EXPRESSLY AUTHORIZED IN BY WRITING STEPPERONLINE.

DIMENSIONS ARE IN MILLIMETERS.
 TOLERANCES AS BELOW:
 DECIMALS ANGLES
 X ±0.5 ±2°
 X.X ±0.25
 X.XX ±0.13

THIRD ANGLE PROJECTION

SIGNATURE DATE

DRN LJ 8.13.2025

APVD YSX 8.13.2025

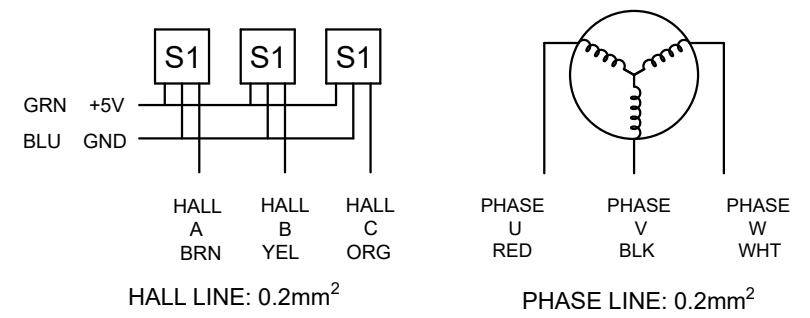

STEPPERONLINE®

BRUSHLESS DC MOTOR

16CL41-12-P2-7300

REV.	0	SCALE	1:1	DWG NO.	A4869
------	---	-------	-----	---------	-------