

CUSTOMER'S MODEL: NO MODEL
 END COVER COLOR: BLACK

REV.	REVISION RECORD	BY	DATE
0	ORIGIN	LJ	4.24.2025

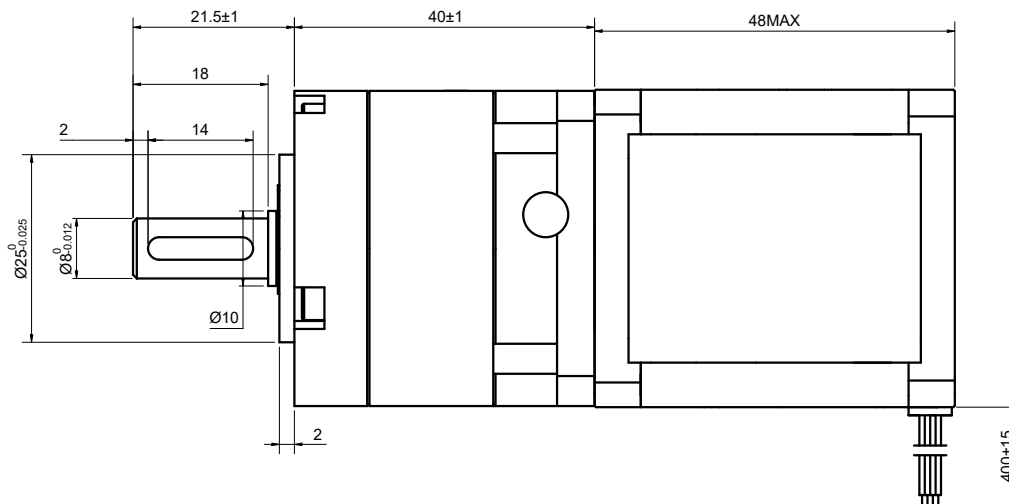
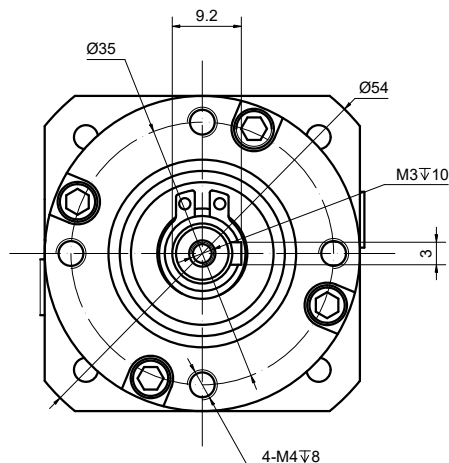

SPECIFICATION	CONNECTION	BIPOLAR
AMPS/PHASE		1.68
RESISTANCE/PHASE(Ohms)@25°C		1.80±10%
INDUCTANCE/PHASE(mH)@1KHz		3.20±20%
HOLDING TORQUE w/o GEARBOX(Nm)[lb-in]		0.52[4.60]
STEP ANGLE w/o GEARBOX(°)		1.80
GEAR RATIO		5
GEAR EFFICIENCY		90%
BACKLASH@NO-LOAD(arcmin)		<=30
MAX.PERMISSIBLE TORQUE(Nm)		9.00
MOMENT PERMISSIBLE TORQUE(Nm)		18.00
AMBIENT TEMPERATURE		-10°C~50°C[14°F~122°F]
INSULATION CLASS		B 130°C[266°F]
TEMPERATURE RISE		MAX.80°C

COMMENT:
 1.DYNAMIC AXIAL LOAD: 50N MAX
 2.DYNAMIC RADIAL LOAD @ SHAFT LENGTH 20mm: 100N MAX
 3.TMBF 6000h OR MORE @ 24V/300RPM
 4.INSULATION RESISTANCE (NORMAL TEMPERATURE AND HUMIDITY): 100 Mohm
 5.DIELECTRIC STRENGTH 500VAC FOR 1MIN.(BETWEEN THE MOTOR COILS AND THE MOTOR CASE)

MOTOR CONNECTION			
PIN NO	BIPOLAR	LEADS	WINDING
1	A+	BLK	
2	A-	GRN	
3	B+	RED	
4	B-	BLU	

FULL STEP 2 PHASE-Ex.,WHEN FACING MOUNTING END (X)						DIMENSIONS ARE IN MILLIMETERS.		
STEP	A+	B+	A-	B-		CCW	TOLERANCES AS BELOW:	
1	+	+	-	-		CCW ↑ ↓ CW	DECIMALS	
2	-	+	+	-			X ±0.5	ANGLES
3	-	-	+	+			X.X ±0.25	±2°
4	+	-	-	+			X.XX ±0.13	
						THIRD ANGLE PROJECTION		

STEPPERONLINE®

STEPPER MOTOR

17HS19-1684S-MG5

THIS DOCUMENT SHALL NOT BE REPRODUCED NOR SHALL THE INFORMATION CONTAINED HEREIN BE USED BY OR DISCLOSED TO OTHERS UNLESS EXPRESSLY AUTHORIZED IN BY WRITING STEPPERONLINE.

SIGNATURE		DATE
DRN	LJ	4.24.2025
APVD	MYX	4.24.2025