

REV.	REVISION RECORD	BY	DATE
0	ORIGIN	MYX	2.17.2025

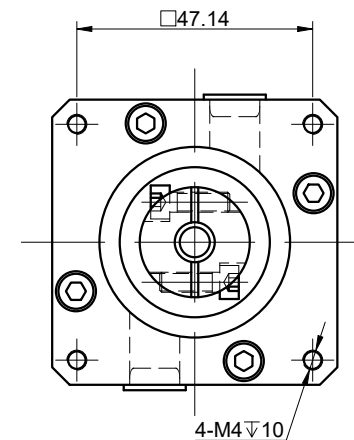
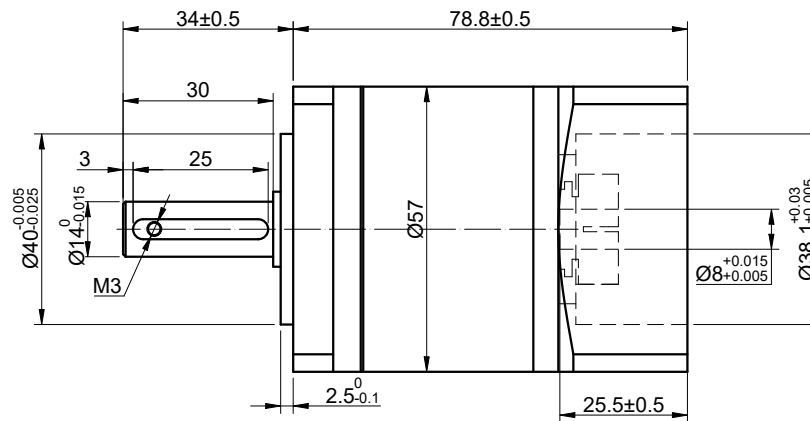
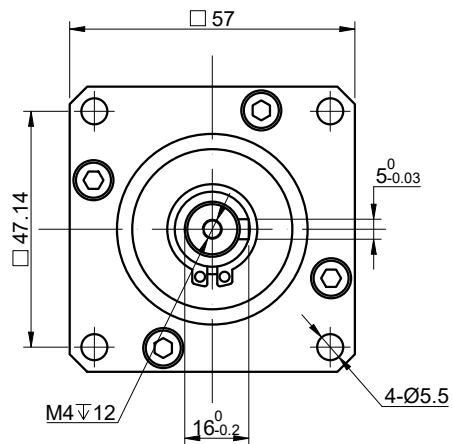

SPECIFICATION	CONNECTION	VALUE
GEAR RATIO		20
EFFICIENCY		80%
BACKLASH@NO-LOAD(arcmin)		<=45
MAX.PERMISSIBLE TORQUE(Nm)[lb-in]		25.00[221.28]
MOMENT PERMISSIBLE TORQUE(Nm)[lb-in]		50.00[442.55]
SHAFT MAXIMUM AXIAL LOAD(N)		100
SHAFT MAXIMUM RADIAL LOAD(N)		300
GEARBOX MATCHING MOTOR'S INPUT SHAFT LENGTH (mm)		20~25
RATED INPUT SPEED(RPM)		1000
MAX. INPUT SPEED(RPM)		2000
NOISE(dB)		<=55
WATERPROOF RATING		IP54
LIFE(h)		20000
WORKING TEMPERATURE		-20°C~150°C[-4°F~302°F]

DIMENSIONS ARE IN MILLIMETERS.
TOLERANCES AS BELOW:

DECIMALS	ANGLES
X ±0.5	±2°
X.X ±0.25	
X.XX ±0.13	

THIRD ANGLE PROJECTION	
SIGNATURE	DATE
DRN MYX	2.17.2025
APVD LDJ	2.17.2025

STEPPERONLINE®

GEARBOX

MGL23-G20-D8

REV.	0	SCALE	1:1	DWG NO.	A4170
------	---	-------	-----	---------	-------