

CUSTOMER'S MODEL: NO MODEL
 END COVER COLOR: BLUE

REV.	REVISION RECORD	BY	DATE
0	ORIGIN	ZPJ	12.31.2025

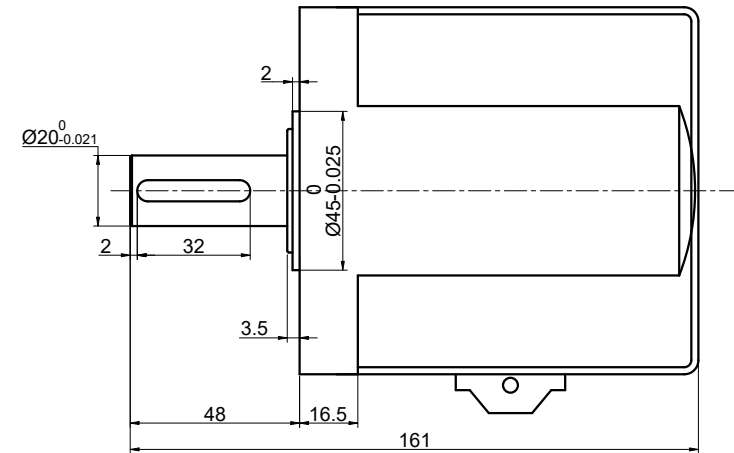
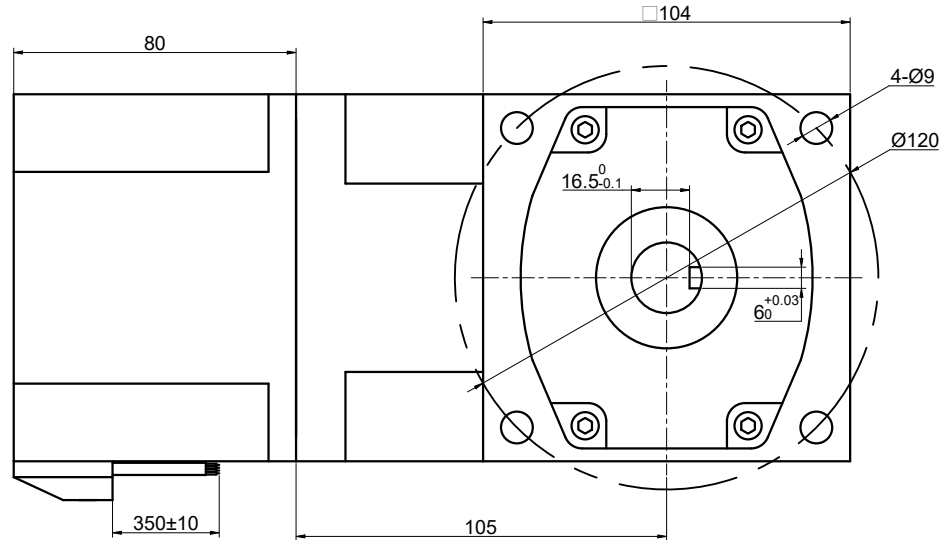

SPECIFICATION	VALUE
NO. of PHASES	3
NO. of POLES	10
RATED VOLTAGE(V):	24
RATED POWER(W):	250
RATED LOAD SPEED(RPM):	150
RATED LOAD TORQUE(N.m):	11.81
RATED CURRENT(A):	13
GEAR RATIO	20
MAX.PERMISSIBLE TORQUE(N.m)	40
AMBIENT TEMPERATURE	-10°C~40°C[14°F~104°F]
INSULATION CLASS	E 120°C[248°F]
TEMPERATURE RISE	MAX.80°C

THIS DOCUMENT SHALL NOT BE REPRODUCED NOR SHALL THE INFORMATION CONTAINED HEREIN BE USED BY OR DISCLOSED TO OTHERS UNLESS EXPRESSLY AUTHORIZED IN BY WRITING STEPPERONLINE.

DIMENSIONS ARE IN MILLIMETERS.
 TOLERANCES AS BELOW:
 DECIMALS ANGLES
 X ±0.5 ±2°
 X.X ±0.25
 X.XX ±0.13

THIRD ANGLE PROJECTION

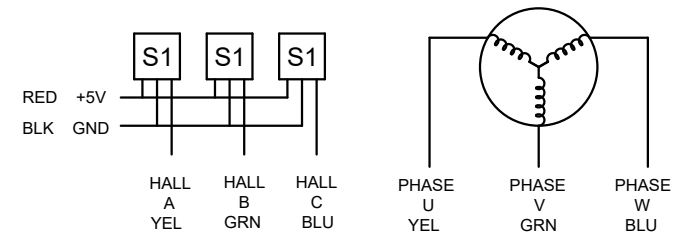

STEPPERONLINE®

GEARED BLDC MOTOR

F6B250-24GU-30S/6GU20RT

SIGNATURE		DATE
DRN	ZPJ	12.31.2025
APVD	MYX	12.31.2025

REV.	0	SCALE	1:1	DWG NO.	A5617
------	---	-------	-----	---------	-------