

CUSTOMER'S MODEL: NO MODEL
 END COVER COLOR: BLUE

REV.	REVISION RECORD	BY	DATE
0	ORIGIN	YSX	2.2.2026

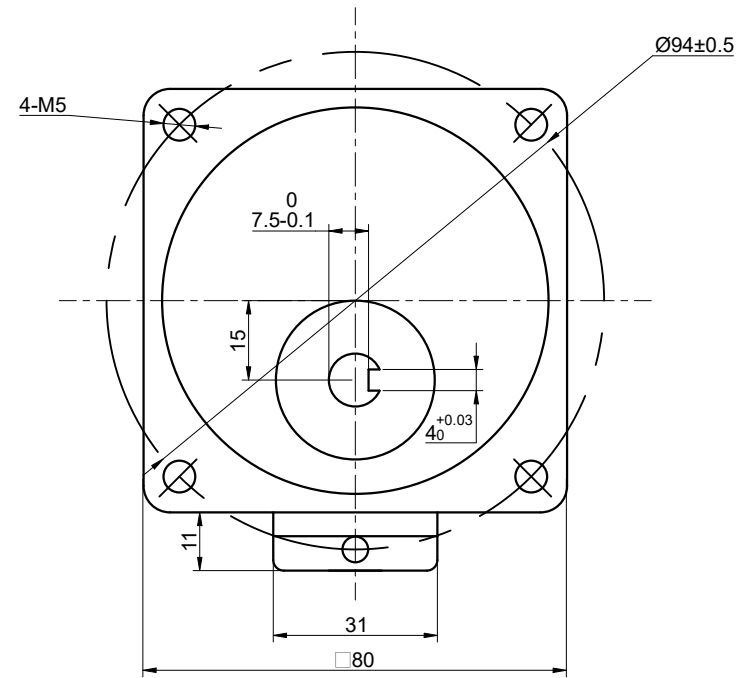
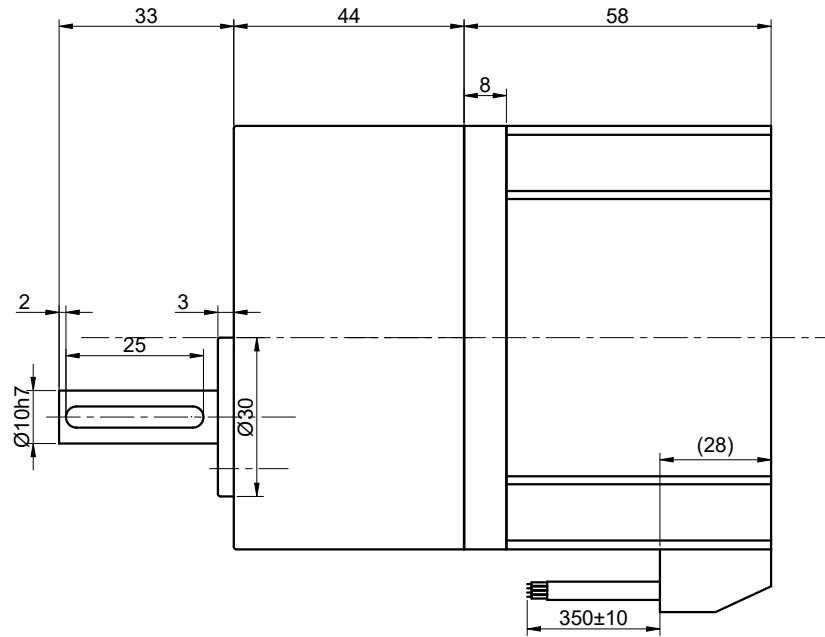

SPECIFICATION	VALUE
NO. of PHASES	3
NO. of POLES	10
RATED VOLTAGE(V):	24
RATED POWER(W):	40
RATED LOAD SPEED(RPM):	15
RATED LOAD TORQUE(N.m):	8
RATED CURRENT(A):	2.50
GEAR RATIO	200
MAX.PERMISSIBLE TORQUE(N.m)	8
AMBIENT TEMPERATURE	-10°C~40°C[14°F~104°F]
INSULATION CLASS	E 120°C[248°F]
TEMPERATURE RISE	MAX.80°C

THIS DOCUMENT SHALL NOT BE REPRODUCED NOR SHALL THE INFORMATION CONTAINED HEREIN BE USED BY OR DISCLOSED TO OTHERS UNLESS EXPRESSLY AUTHORIZED IN BY WRITING STEPPERONLINE.

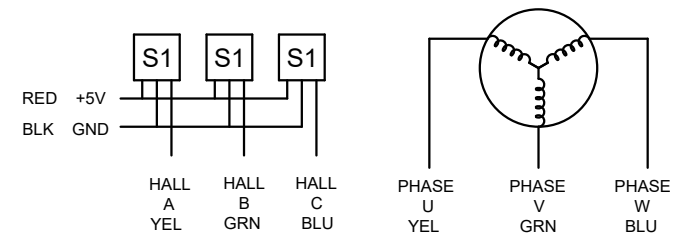

DIMENSIONS ARE IN MILLIMETERS.
 TOLERANCES AS BELOW:
 DECIMALS ANGLES
 X ±0.5 ±2°
 X.X ±0.25
 X.XX ±0.13

THIRD ANGLE PROJECTION

STEPPERONLINE®

GEARED BLDC MOTOR

F4B40-24GN-30S/4GN200K

SIGNATURE		DATE
DRN	YSX	2.2.2026
APVD	ZPJ	2.2.2026

REV.	0	SCALE	1:1	DWG NO.	A5389
------	---	-------	-----	---------	-------