

CUSTOMER'S MODEL: NO MODEL  
 END COVER COLOR: BLUE

REV.	REVISION RECORD	BY	DATE
0	ORIGIN	YSX	12.25.2025

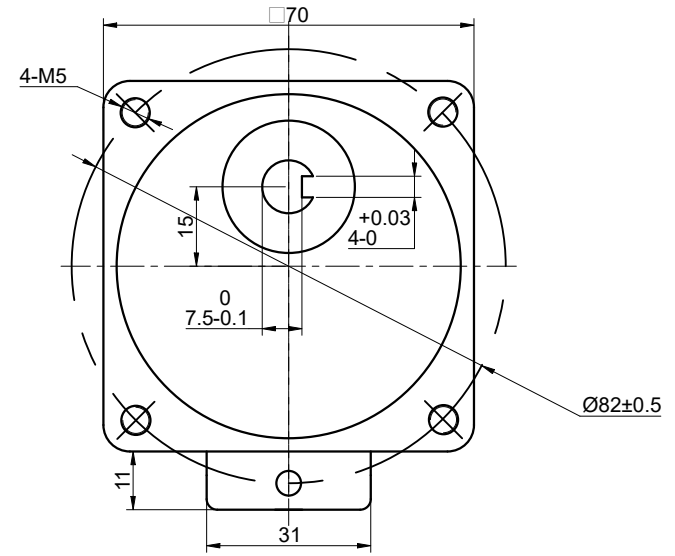
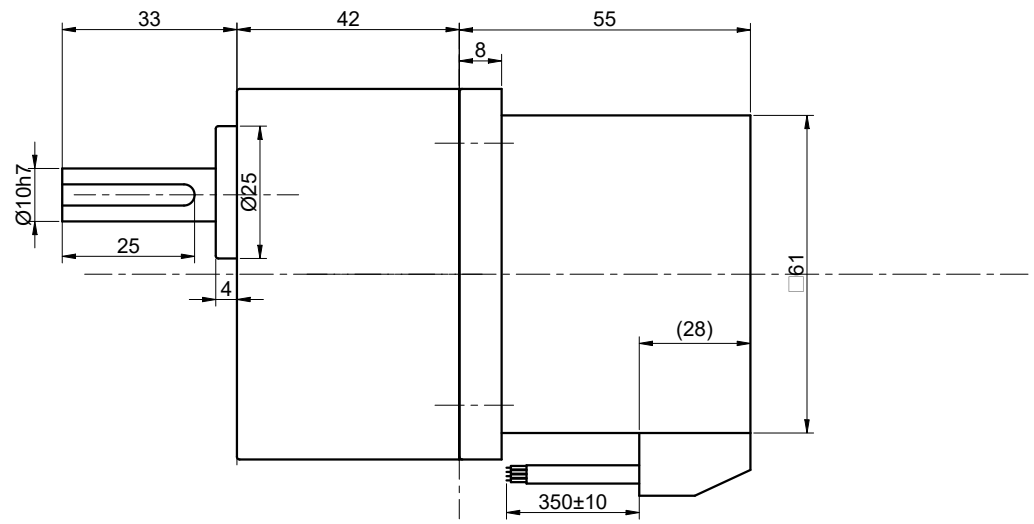

SPECIFICATION	VALUE
NO. of PHASES	3
NO. of POLES	10
RATED VOLTAGE(V):	48
RATED POWER(W):	40
RATED LOAD SPEED(RPM):	600
RATED LOAD TORQUE(N.m):	0.52
RATED CURRENT(A):	1.30
GEAR RATIO	5
MAX.PERMISSIBLE TORQUE(N.m)	5
AMBIENT TEMPERATURE	-10°C~40°C[14°F~104°F]
INSULATION CLASS	E 120°C[248°F]
TEMPERATURE RISE	MAX.80°C

THIS DOCUMENT SHALL NOT BE REPRODUCED NOR SHALL THE INFORMATION CONTAINED HEREIN BE USED BY OR DISCLOSED TO OTHERS UNLESS EXPRESSLY AUTHORIZED IN BY WRITING STEPPERONLINE.

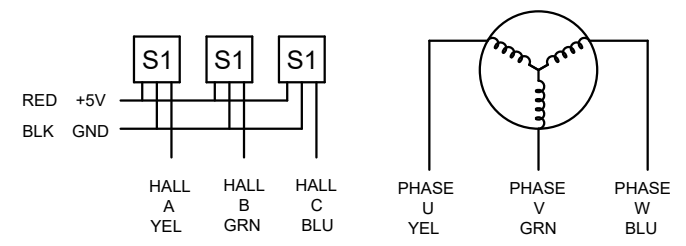

DIMENSIONS ARE IN MILLIMETERS.  
 TOLERANCES AS BELOW:  
 DECIMALS ANGLES  
 X ±0.5 ±2°  
 X.X ±0.25  
 X.XX ±0.13

THIRD ANGLE PROJECTION

**STEPPERONLINE®**

**GEARED BLDC MOTOR**

**F3B40-48GN-30S/3GN5K**

REV.	0	SCALE	1:1	DWG NO.	A5373
------	---	-------	-----	---------	-------

SIGNATURE		DATE
DRN	YSX	12.25.2025
APVD	ZPJ	1.5.2026