

SPECIFICATION	CONNECTION	VALUE
GEAR RATIO		10
EFFICIENCY		96.00%
BACKLASH@NO-LOAD(arcmin)		<=15
MAX.PERMISSIBLE TORQUE(Nm)[lb-in]		39.00[345.18]
MOMENT PERMISSIBLE TORQUE(Nm)[lb-in]		78.00[690.36]
GEARBOX MATCHING MOTOR'S INPUT SHAFT LENGTH (mm)		30~40
NOISE(dB)		<=60
WATERPROOF RATING		IP54
LIFE(h)		20000
AMBIENT TEMPERATURE		-10°C~90°C[14°F~194°F]

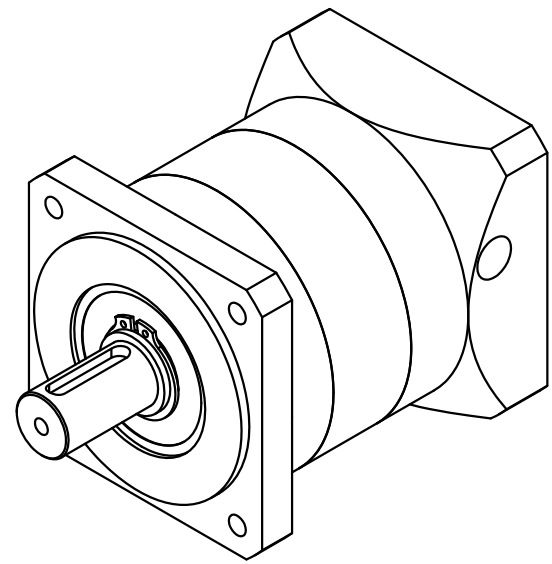

STEPPERONLINE®

	APVD		10.15.2021
	CHKD		
1:2	DRN		
SCALE	SIGNATURE		DATE

PLANETARY GEARBOX

PLE34-G10