

SPECIFICATION	CONNECTION		
	UNIPOLAR	BIPOLAR (SERIAL)	BIPOLAR (PARALLEL)
AMPS/PHASE	4.00	2.83	5.66
RESISTANCE/PHASE(Ohms)@25°C	0.80±10%	1.60±10%	0.40±10%
INDUCTANCE/PHASE(mH)@1KHz	1.80±20%	7.20±20%	1.80±20%
HOLDING TORQUE(Nm)[lb-in]	2.00[17.70]	2.83[25.05]	2.83[25.05]
STEP ANGLE(°)	1.80		
STEP ACCURACY(NON-ACCUM)	±5.00%		
ROTOR INERTIA(g-cm²)	530.00		
WEIGHT(Kg)[lb]	1.13[2.49]		
TEMPERATURE RISE:MAX.80°C (MOTOR STANDSTILL;FOR 2PHASE ENERGIZED)			
AMBIENT TEMPERATURE -10°C~50°C[14°F~122°F]			
INSULATION RESISTANCE 100 Mohm (UNDER NORMAL TEMPERATURE AND HUMIDITY)			
INSULATION CLASS B 130°C[266°F]			
DIELECTRIC STRENGTH 500VAC FOR 1MIN.(BETWEEN THE MOTOR COILS AND THE MOTOR CASE)			
AMBIENT HUMIDITY MAX.85%(NO CONDENSATION)			

UNIPOLAR

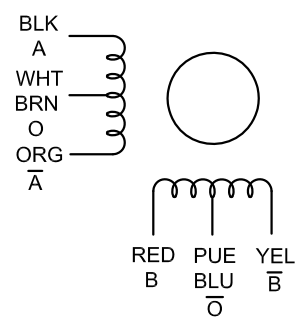

BIPOLAR SERIES

BIPOLAR PARALLEL

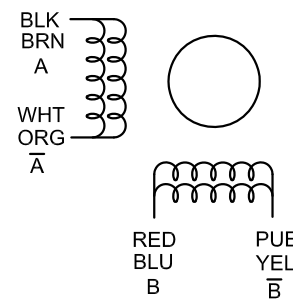

APVD		8.18.2018
CHKD		
1:1.5	DRN	
SCALE	SIGNATURE	DATE

STEPPER MOTOR

23HS33-4008D